

1	Type	M12 Lens	
2	Resolution	16MP	
3	Image Format	1/1.8"	
4	Image Circle	φ9.39mm(MAX)	
5	EFL	4.45mm	
6	TTL	25.50mm	
7	F/NO.	F2.5	
8	FFL (M)	2.60mm	
9	BFL (O)	4.16mm	
10	For Sensor	1/2.3" IMX577	1/1.8" IMX334
11	F.O.V	Horizontal	72° @6.29mm 83° @7.68mm
12		Vertical	56° @4.71mm 52° @4.32mm
13		Diagonal	84° @7.86mm 89° @8.81mm
14	OPT Distortion	<1.5% @7.86mm	<3.3% @8.81mm
15	Relative Ill.	>85% @7.86mm	>57% @8.81mm
16	Chief Ray Angle	<13.6°	
17	M.O.D	0.1m~∞	
18	Mount Type	M12*P0.5	
19	Dimension Figure	φ17.4*L22.90mm	
20	Lens Structure	8G	
21	IR-Filter	IR650nm	
22	Waterproof	No	
23	Weight	7.0g	
24	Iris Operation	Fixed	
25	Zoom Operation	Fixed	
26	Focus Operation	Manual	
27	Operating Temperature	-20° ~+85°	
28	Storage Temperature	-20° ~+85°	

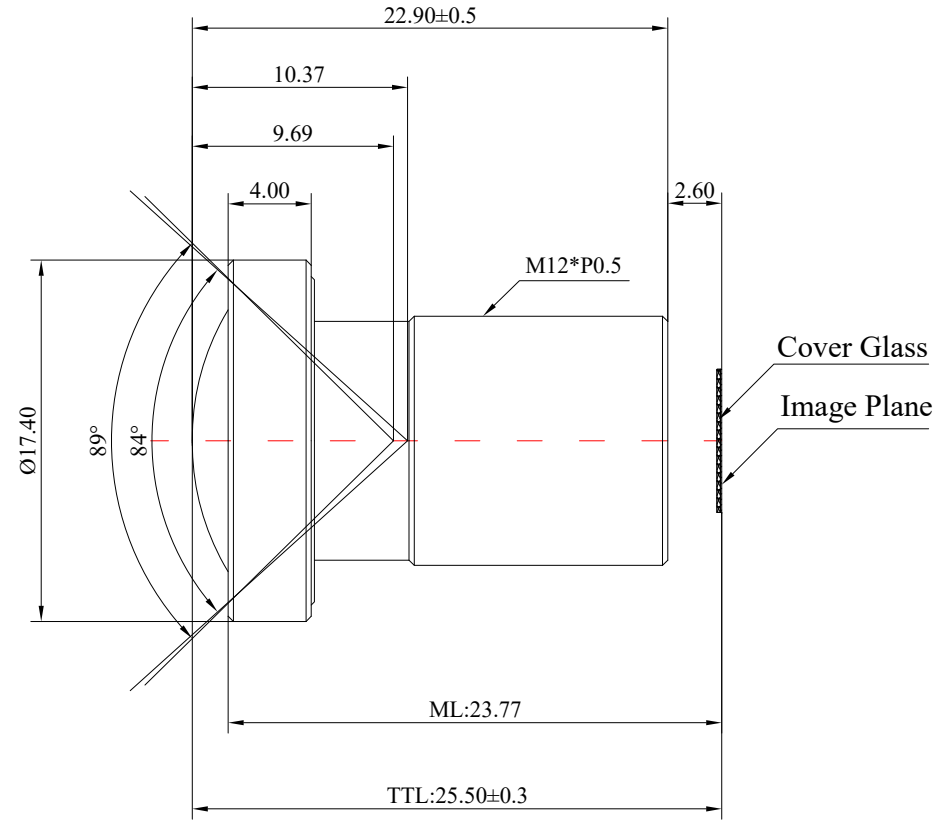

Scale	Remark	Tolerances	Date	Revised	
4:1	X	±0.2	2022-12-22	CH8053AB Rev1.0	
	X.0	±0.15			
Units	X.00	±0.10	Design	Linda	2022-12-05
	X.000	±0.001	Checked	Anna	2022-12-09
mm	Angle	±0.5°	Approval	Sanmu	2022-12-22

福州创安光电科技有限公司
FUZHOU CHUANGAN OPTICS CO., LTD

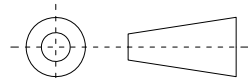

3D Angle Projection